

Ovalis 3 Basin

Est. Weight: 37 lbs (16.8 kg)
Est. Water Capacity: 2.4 gal (9 litres)

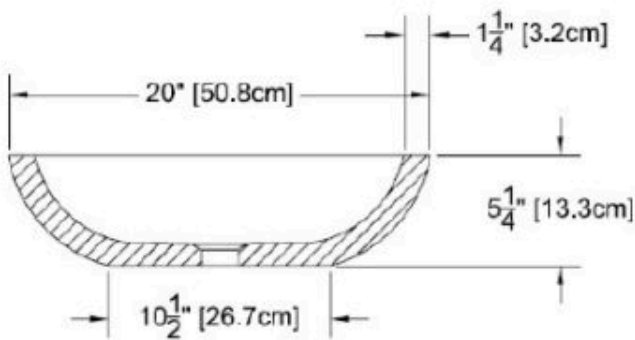
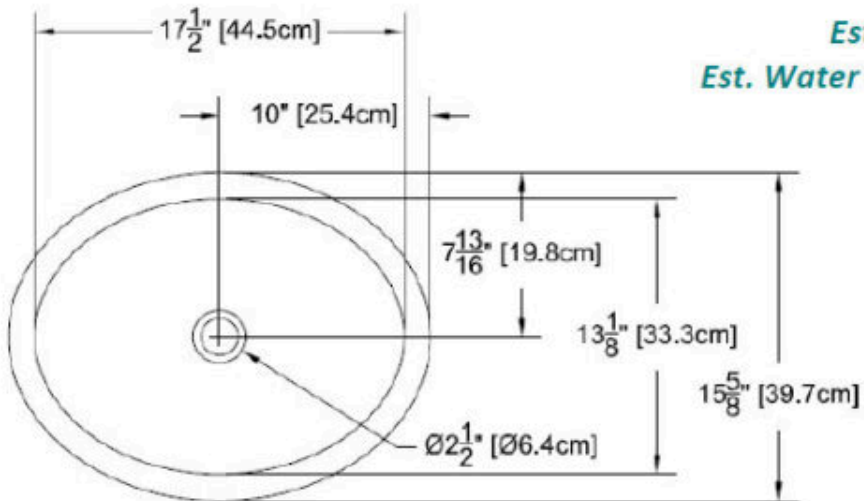

Our products comply with one or more of the following: IAPMO, ANSI, HUD, NAHB, NHQ

Drain Details:

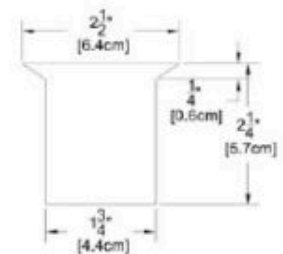

Drain dimensions may vary slightly