



Model: TL-T10-1700

Approximate cast weight: 266lbs (120kg)

Water consumption: 49gallons (185litres)

Key features include:

Solid one-piece construction with integral overflow

Pre-sloped to drain

Mold and mildew resistant

Bacteria resistant

Non-porous

Stain resistant and easy to clean

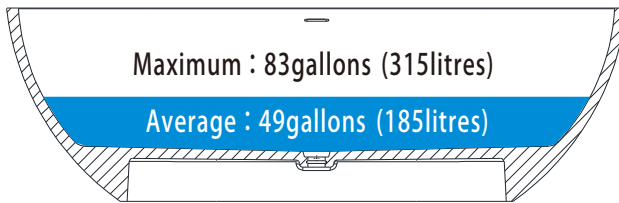

Water consumption

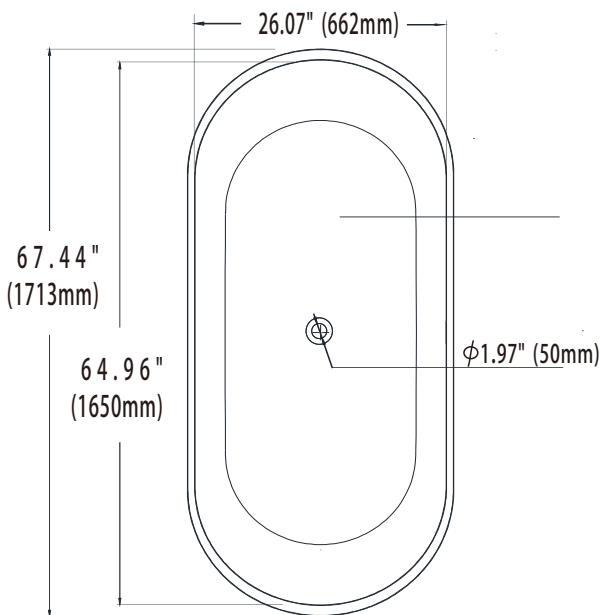

Uniform Plumbing Code (UPC)®

National Plumbing Code of Canada

International Plumbing Code (IPC)®

